

F

E

D

C

B

A

ZONE	SYMBOL	REVISION	APPROVAL	DATE

RoHS
Compliant

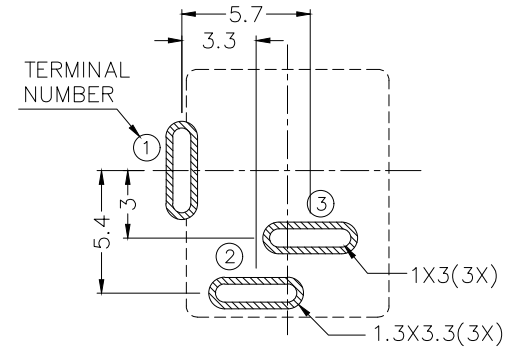
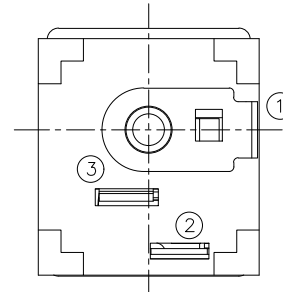
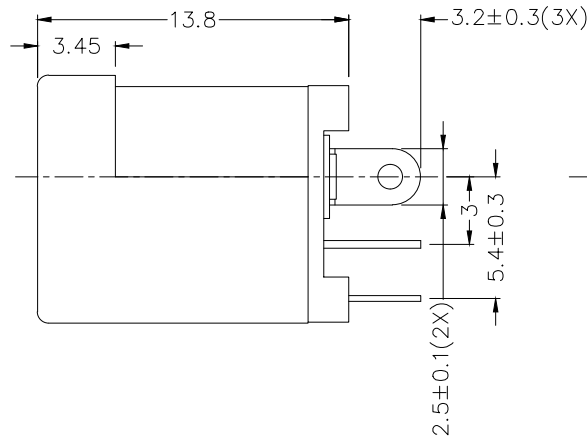
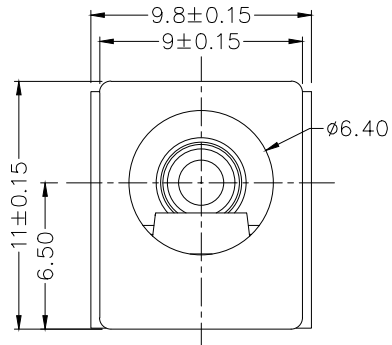
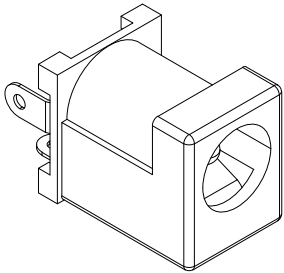

RECOMMENDED PCB LAYOUT
TOLERANCE: ±0.05
(TOP VIEW)

*** MATERIAL**

- CENTRE PIN : BRASS
- TERMINAL 1 : BRASS
- TERMINAL 2 : COPPER ALLOY
- TERMINAL 3 : BRASS
- HOUSING : THERMOPLASTIC
- COVER : THERMOPLASTIC

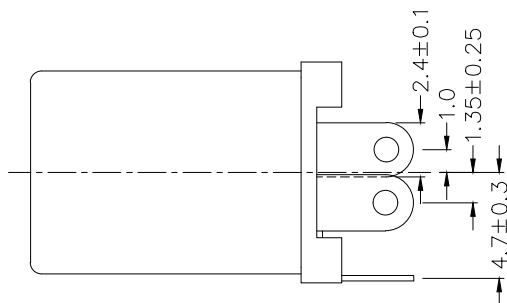

MODEL NO.	LDC-121
SCHEMATIC	
CENTER PIN	φ1.65±0.05mm
	φ2±0.05mm
	φ2.5±0.05mm

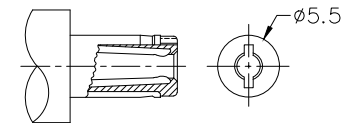

RECOMMENDED
DC MATING PLUG



LINKPLEX TECHNOLOGY LIMITED

PART NAME	DC POWER SOCKET	TOLERANCE UNLESS	0±0.3	UNIT: mm
PART NO.	LDC-121	OTHERWISE SPECIFIED:	0.0±0.25 0.00±0.2	

DESIGN	T.Y.LI	DATE	25-6-2023	SCALE	3:1
DRAWING	H.Q.ZHOU	DATE	25-6-2023	MATERIAL	*
CHECK	H.L.TAN	DATE	25-6-2023	DWG. NO.	TZ\DC121-B/1.0
APPROVAL		DATE	25-6-2023	SHEET	1/1

F

E

D

C

B

A