

F

E

D

C

B

A

RoHS
Compliant

ZONE	SYMBOL	REVISION	APPROVAL	DATE

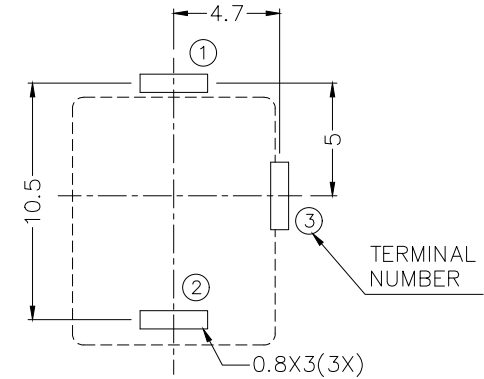
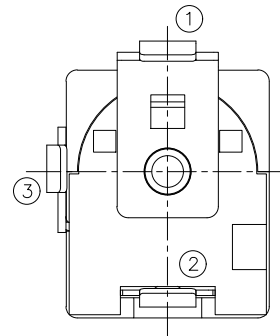
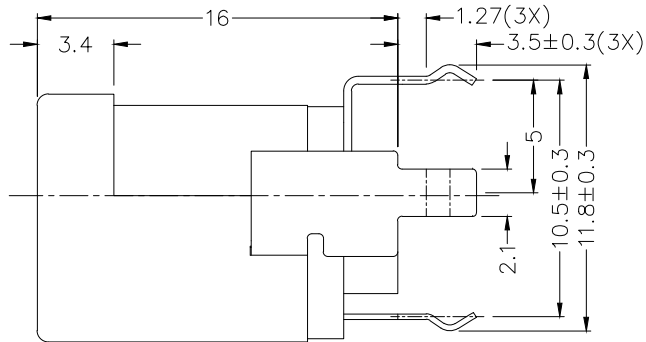
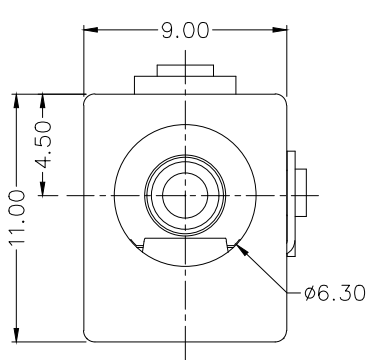
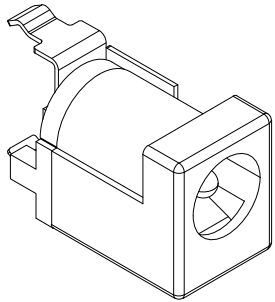

RECOMMENDED PCB LAYOUT
TOLERANCE: ±0.05
(TOP VIEW)

* MATERIAL

- CENTRE PIN : BRASS
- TERMINAL 1 : COPPER ALLOY
- TERMINAL 2 : COPPER ALLOY
- TERMINAL 3 : COPPER ALLOY
- HOUSING : THERMOPLASTIC
- COVER : THERMOPLASTIC

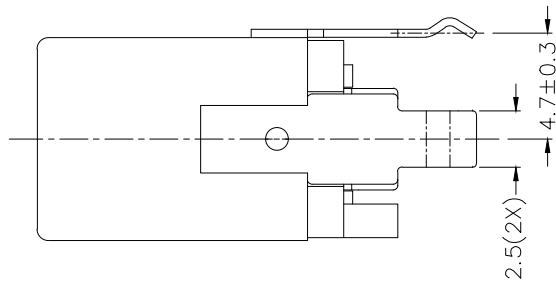

MODEL NO.	LDC-120
SCHMATIC	
CENTER PIN	$\phi 2 \pm 0.05 \text{mm}$
	$\phi 2.5 \pm 0.05 \text{mm}$

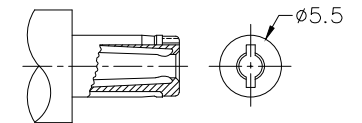

RECOMMENDED
DC MATING PLUG

LINKPLEX TECHNOLOGY LIMITED

PART NAME	DC POWER SOCKET	TOLERANCE UNLESS	0±0.3	UNIT:		DESIGN	T.Y.LI	DATE	25-6-2023	SCALE	3:1
PART NO.	LDC-120	OTHERWISE SPECIFIED:	0.0±0.25 0.00±0.2	mm		CHECK	H.L.TAN	DATE	25-6-2023	MATERIAL	*
						APPROVAL		DATE	25-6-2023	DWG. NO.	TZ\DC120-B/1.0
										SHEET	1/1

F

E

D

C

B

A