

F

E

D

C

B

A

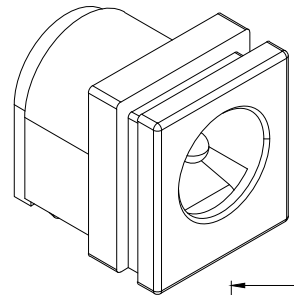

RoHS
Compliant

ZONE	SYMBOL	REVISION	APPROVAL	DATE

1

1

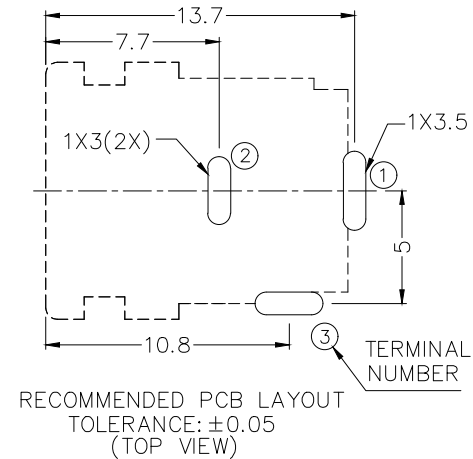
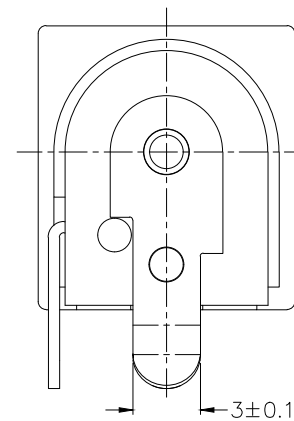
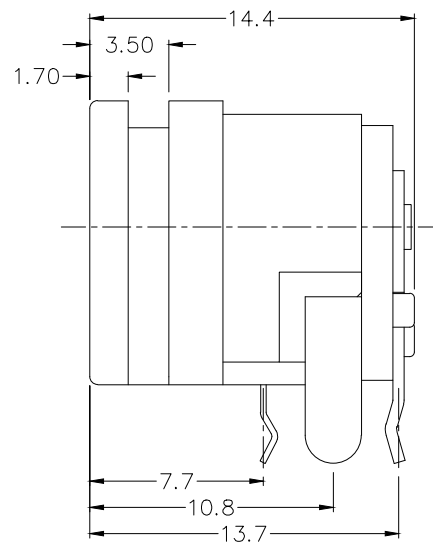
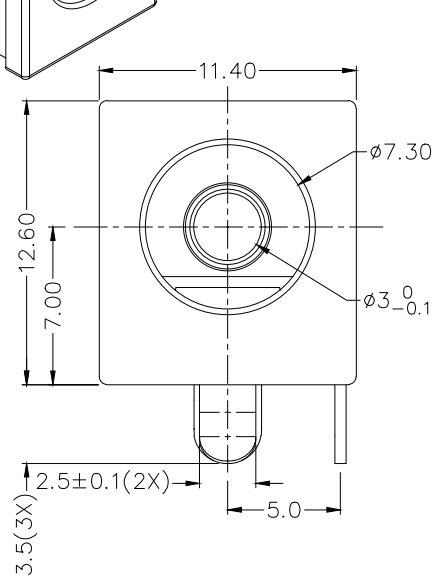

2

2

3

3

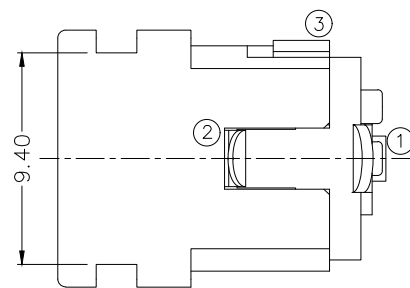

* MATERIAL

- CENTRE PIN : BRASS
- TERMINAL 1 : BRASS
- TERMINAL 2 : COPPER ALLOY
- TERMINAL 3 : BRASS
- HOUSING : THERMOPLASTIC
- COVER : THERMOPLASTIC

MODEL NO.	LDC-040H-2-3.0
SCHEMATIC	

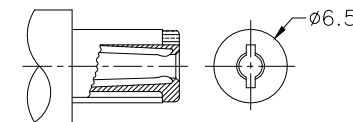

RECOMMENDED
DC MATING PLUG

4

4



LINKPLEX TECHNOLOGY LIMITED

PART NAME	HIGH CURRENT DC POWER SOCKET	TOLERANCE UNLESS	0±0.3 0.0±0.25 OTHERWISE SPECIFIED: 0.00±0.2	UNIT:	mm	DESIGN	T.Y.LI	DATE	11-10-2003	SCALE	3:1
PART NO.	LDC-040H-2					DRAWING	N.X.LIU	DATE	2-11-2016	MATERIAL	*
						CHECK	H.L.TAN	DATE	2-11-2016	DWG. NO.	TZ\DC040H-2-3.0-B/1.0
						APPROVAL		DATE	2-11-2016	SHEET	1/1

F

E

D

C

B

A