

F

E

D

C

B

A

RoHS
Compliant

ZONE	SYMBOL	REVISION	APPROVAL	DATE
		ADJUST THE RECOMMENDED DC	H.Q.ZHOU	10-9-2023
		MATING PLUG		

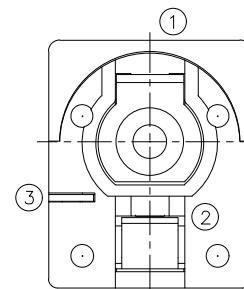
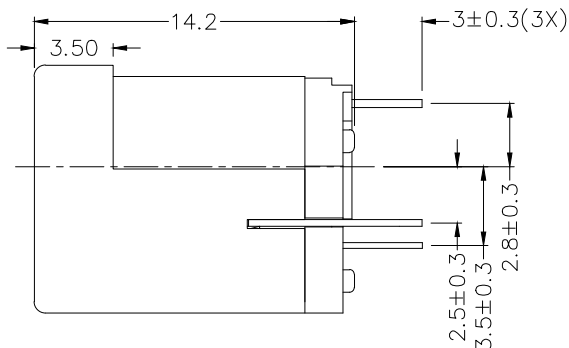
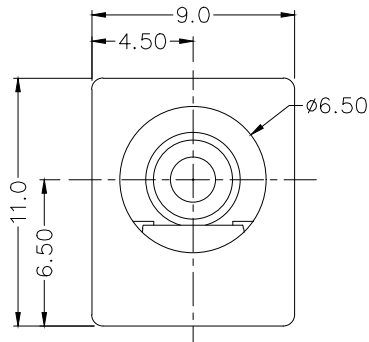
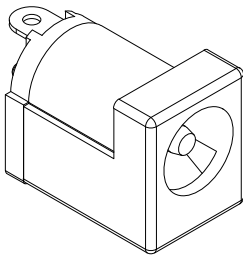

MODEL NO.	LDC-030
SCHEMATIC	
CENTER PIN	ø2mm
	ø2.5mm

* MATERIAL

CENTRE PIN : COPPER
 TERMINAL 1 : BRASS
 TERMINAL 2 : COPPER ALLOY
 TERMINAL 3 : BRASS
 HOUSING : THERMOPLASTIC
 COVER : THERMOPLASTIC

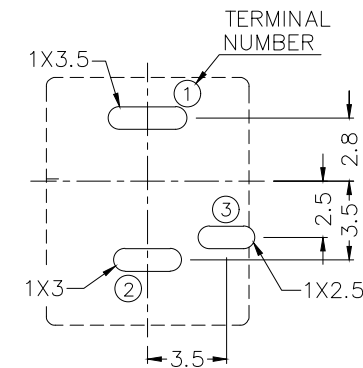
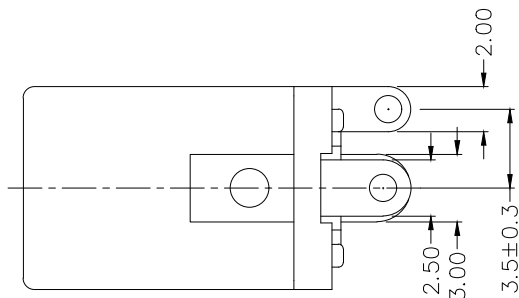

RECOMMENDED PCB LAYOUT
 TOLERANCE: ±0.05
 (TOP VIEW)

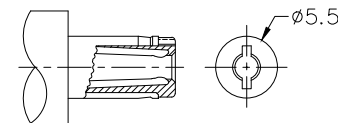

RECOMMENDED
 DC MATING PLUG



LINKPLEX TECHNOLOGY LIMITED

DESIGN	J.X.KUANG	DATE	7-4-2005	SCALE	4:1
DRAWING	J.H.ZHOU	DATE	10-9-2023	MATERIAL	*
CHECK	T.Y.LI	DATE	10-9-2023	DWG. NO.	TZ\DC030-B/1.1
APPROVAL	H.Q.ZHOU	DATE	10-9-2023	SHEET	1/1

PART NAME	DC POWER SOCKET	TOLERANCE UNLESS	0.0±0.2	UNIT:
PART NO.	LDC-030	OTHERWISE SPECIFIED:	0.00±0.1 0.000±0.05	

F

E

D

C

B

A